

1/4

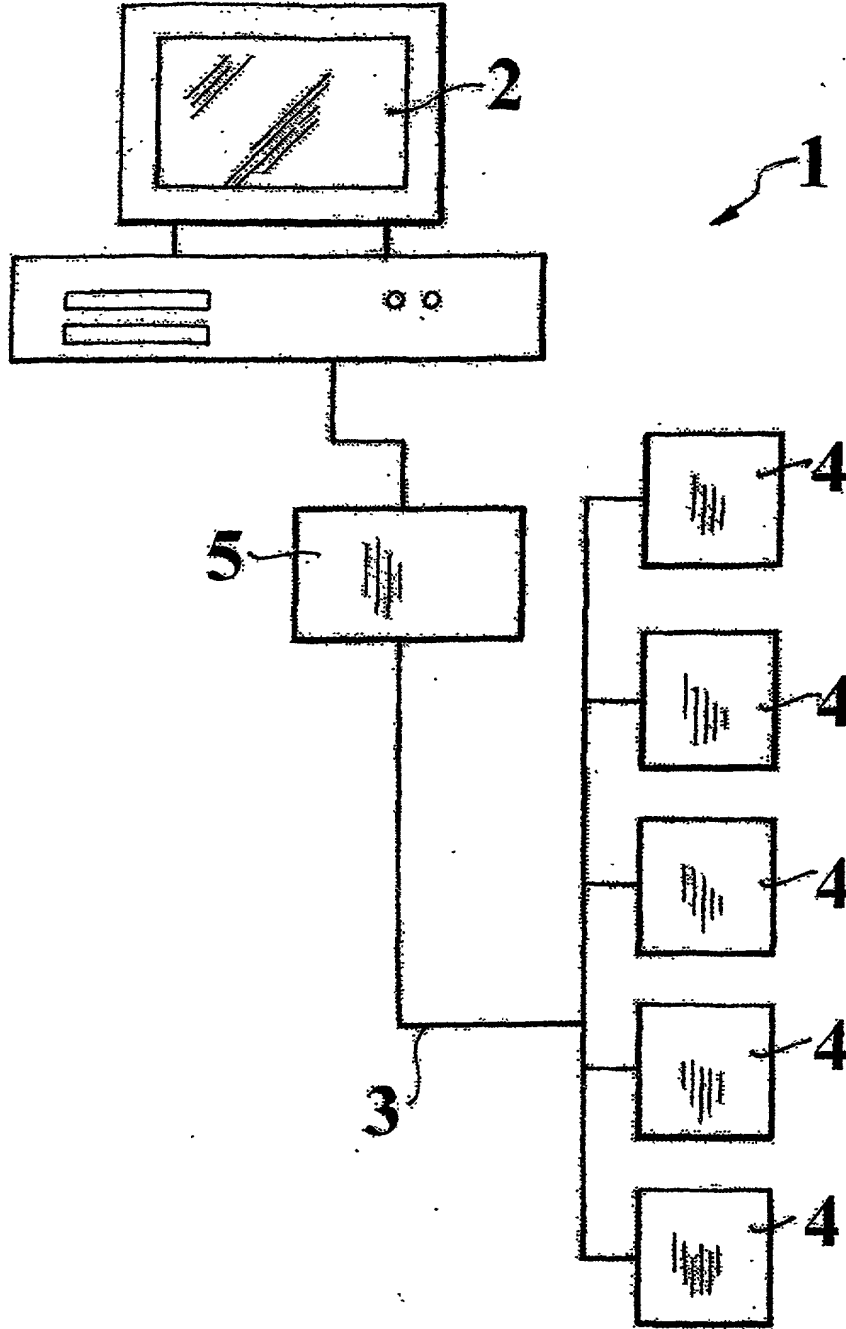
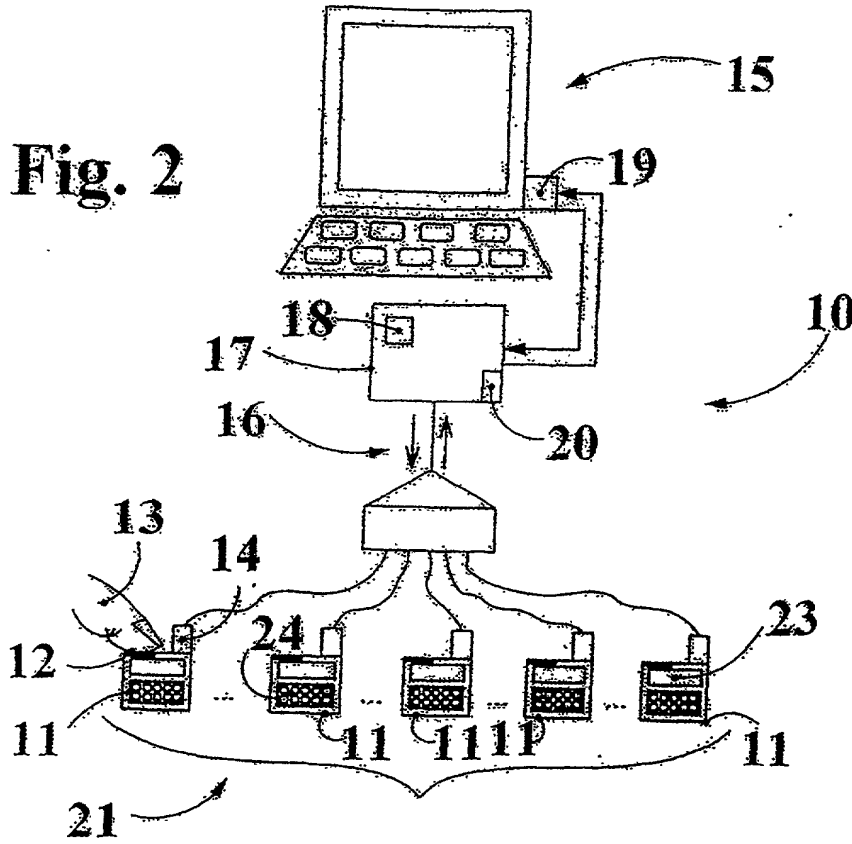

Fig. 1

2010020 00261001

Fig. 2



EP0184507A1

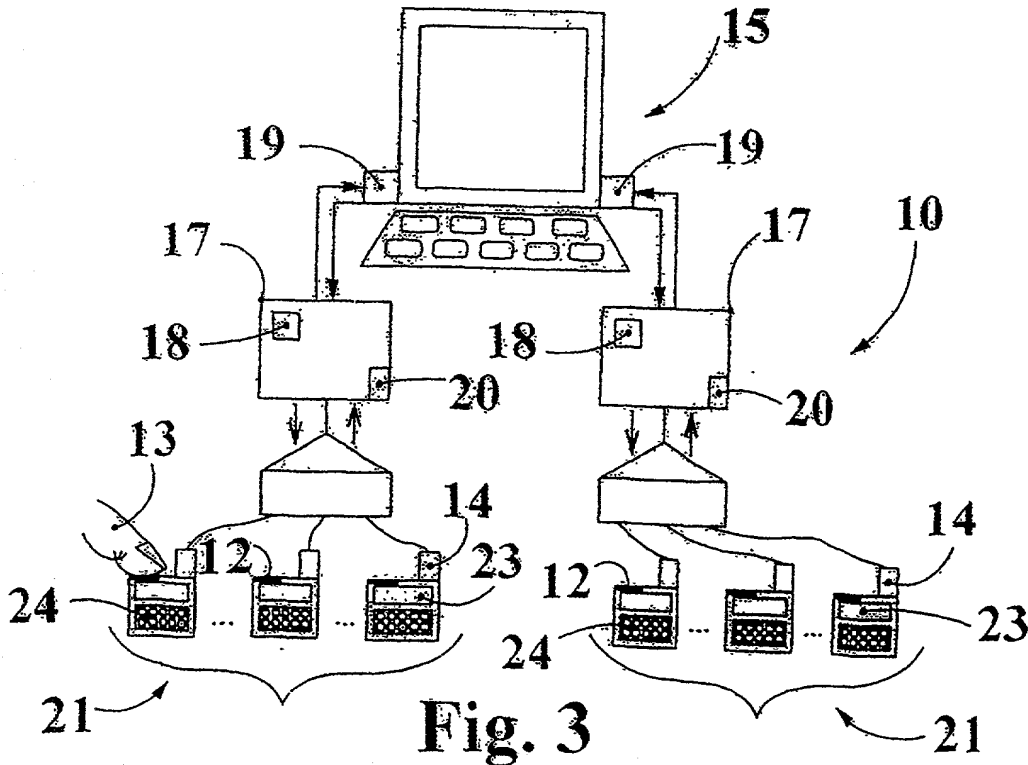

Fig. 3

3/4

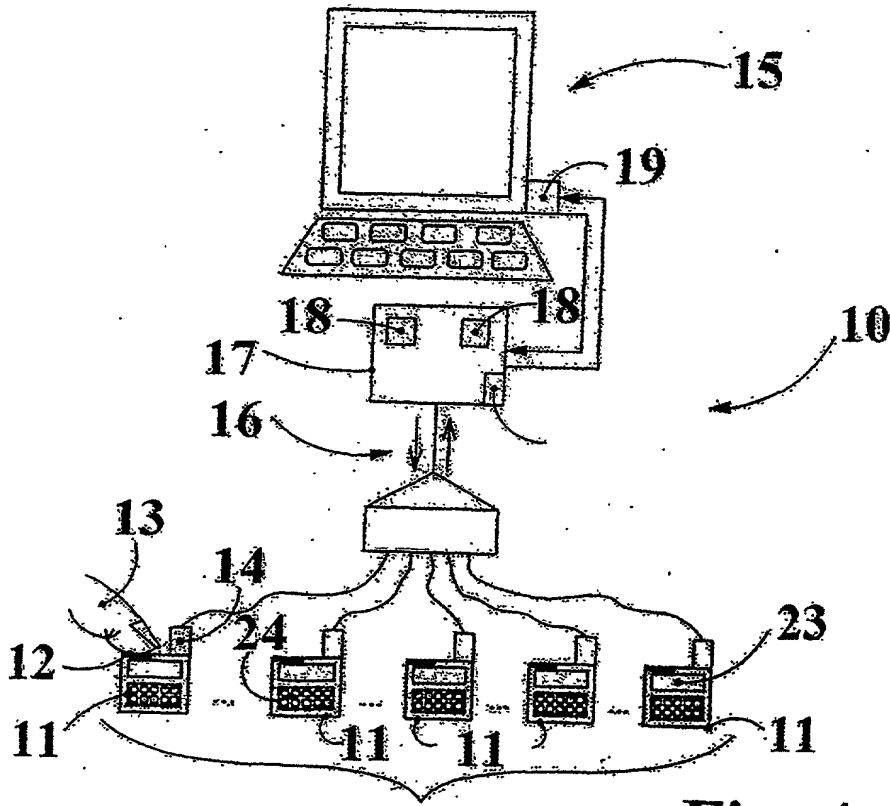

Fig. 4

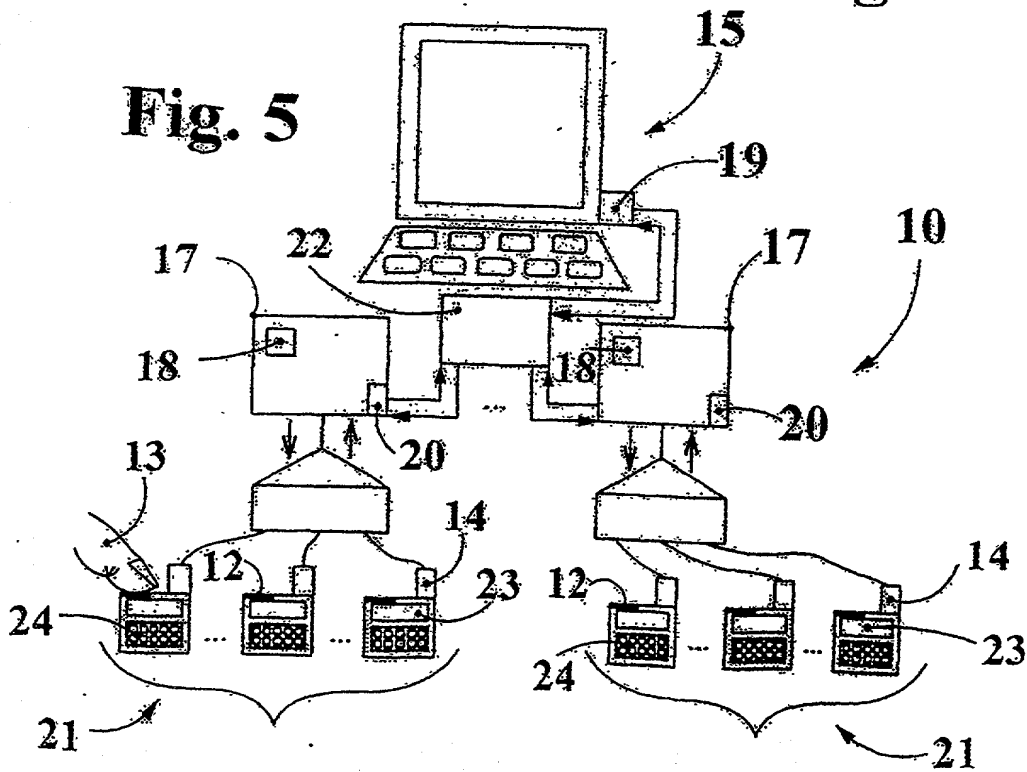

Fig. 5

201020" 0826T001

4/4

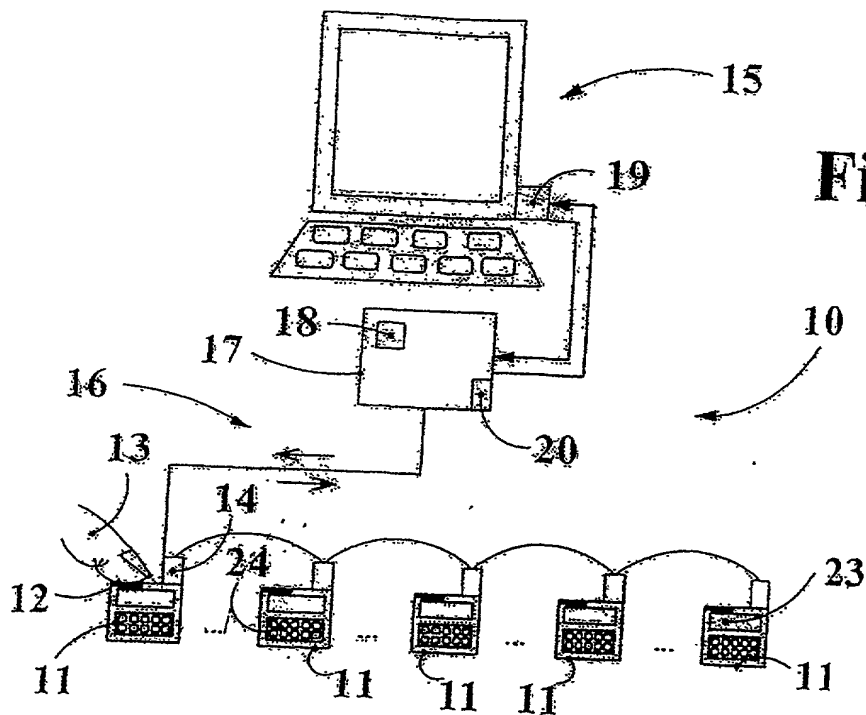

Fig. 6

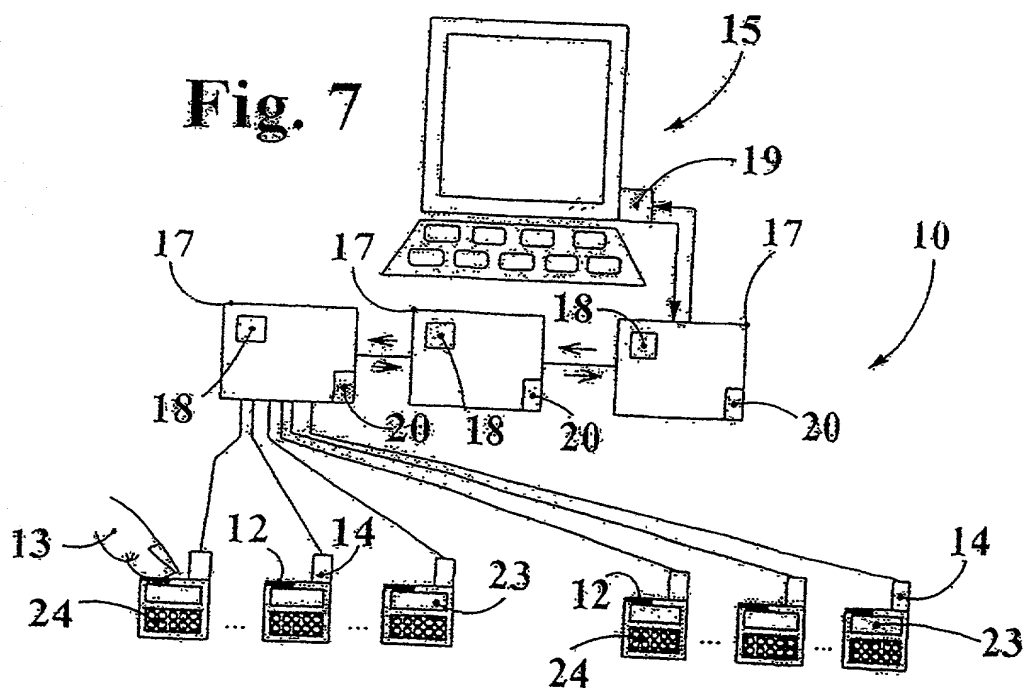

Fig. 7

20140208 0846T001